

INSTRUCTION MANUAL

Model: Pivot Pendel Ø40cm

**halo
design**

COPENHAGEN

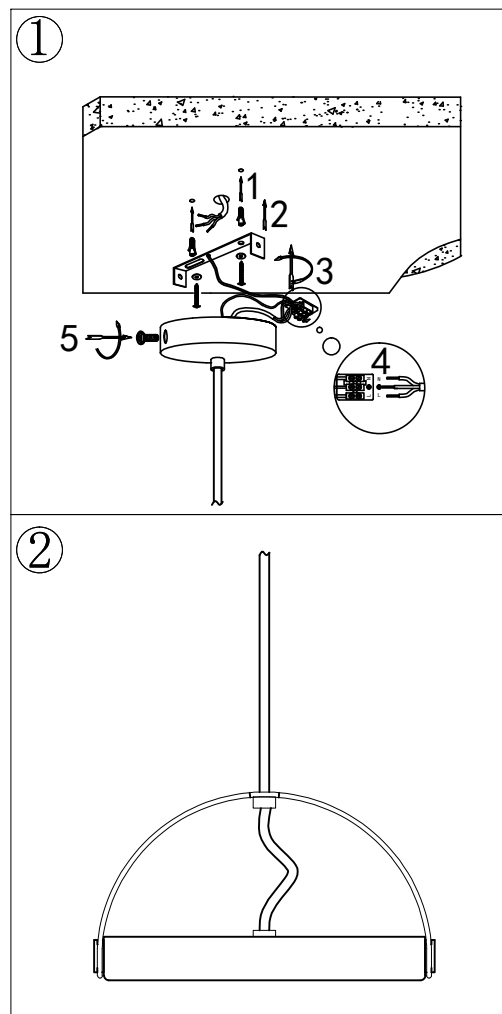
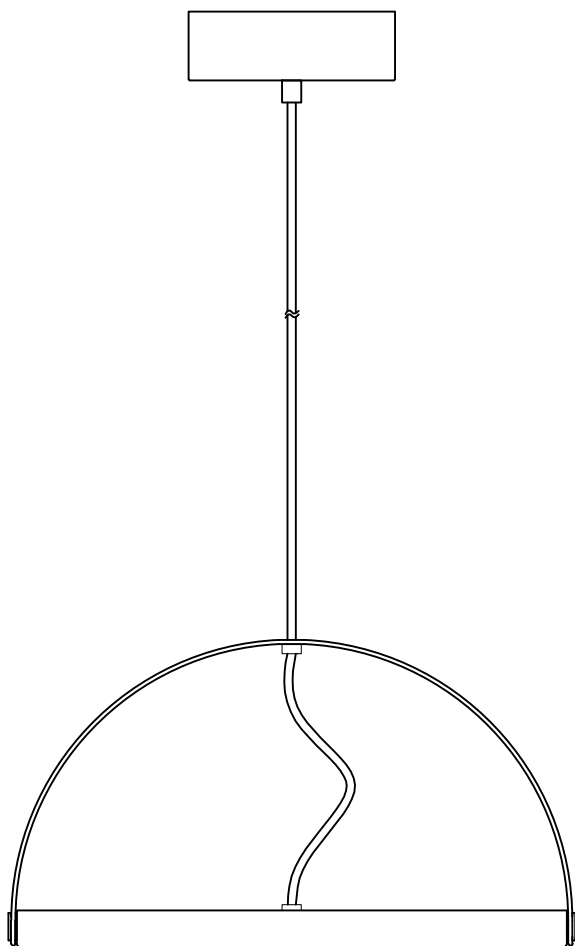

INSTRUCTION MANUAL

- 1 Follow the instruction sketch.
- 2 Make sure power is OFF on the outlet, before beginning the installation.
- 3 Go through point 1 to 2 before connecting the lamp to the power.

3 STEP DIM WITH MEMORY

1st step 100% light

2nd step 50% light

3rd step 15% light

The driver will remember the last setting

230V.LED.MAX 20W

