

NINJA®

Speedi

10-in-1 Rapid Cooker

ON400UK

INSTRUCTIONS



THANK YOU

for purchasing the Ninja® Speedi Rapid Cooker



REGISTER YOUR PURCHASE



ninjakitchen.co.uk/register-guarantee



Scan QR code using mobile device

RECORD THIS INFORMATION

Model Number: _____

Serial Number: _____

Date of Purchase: _____

(Keep receipt)

Store of Purchase: _____

TECHNICAL SPECIFICATIONS

Voltage: 230V~, 50Hz

Watts: 1760W

TIP: You can find the model and serial numbers on the QR code label on the back of the unit by the power cord.

PRODUCT REGISTRATION

Please visit registeryourninja.com or call 0800 862 0453 to register your new Ninja® product within 28 days of purchase. You will be asked to provide the store name, date of purchase, and model number along with your name and address.

The registration will enable us to contact you in the unlikely event of a product safety notification.

CONTENTS

Important Safeguards	2
Parts & Accessories	4
Before First Use	4
Accessory Assembly & Smart Switch	5
Using the Control Panel	6
Operating Buttons	6
Cooking Functions	6
Using the Rapid Cooker Functions	7
Speedi Meals	7
Steam Air Fry	7
Steam Bake	8
Steam	8
Using the Air Fry/Hob Functions	9
Grill	9
Air Fry	9
Bake/Roast	10
Dehydrate	10
Sear/Sauté	11
Slow Cook	11
Cleaning & Maintenance	12
Dishwasher & Hand-Washing	12
Cleaning the Lid	12
Troubleshooting Guide	13
Helpful Tips	13

IMPORTANT SAFEGUARDS

HOUSEHOLD USE ONLY • READ ALL INSTRUCTIONS BEFORE USE

⚠ WARNING

- 1 To eliminate a choking hazard for young children, discard all packaging materials immediately upon unpacking.
- 2 This appliance can be used by persons with reduced physical, sensory or mental capabilities or lack of experience or knowledge if they have been given supervision and instruction concerning use of the appliance in a safe way and understand the hazards involved.
- 3 Keep the appliance and its cord out of reach of children. **DO NOT** allow children to play with or use the appliance. Close supervision is necessary when used near children.
- 4 Spilled food can cause serious burns. **DO NOT** let cord hang over edges of tables or worktops or place appliance on or near hot surfaces, on or near a gas or electric burner or in a heated oven.
- 5 **DO NOT** place appliance on or near a gas or electric hob or in a heated oven.
- 6 Serious burns can result from the steam and hot foods inside the inner pot. **ALWAYS** keep hands, face and other body parts away from the release valve prior to or during release and when opening the lid after cooking.
- 7 **DO NOT** use the appliance without the cooking pot installed.
- 8 Before placing removable cooking pot in the cooker base, ensure pot and cooker base are clean and dry by wiping with a soft cloth.
- 9 When removable cooking pot is empty, **DO NOT** heat it for more than 10 minutes. Doing so may damage the cooking surface.
- 10 **DO NOT** use this appliance for deep-frying.
- 11 Caution should be used when searing meats and sautéing. Keep hands and face away from the removable cooking pot, especially when adding new ingredients, as hot oil may splatter.
- 12 This appliance is for household use only. **DO NOT** use this appliance for anything other than its intended use. **DO NOT** use in moving vehicle or boats. **DO NOT** use outdoors. Misuse may cause injury.
- 13 Intended for worktop use only. Ensure the surface is level, clean, and dry. **DO NOT** place the appliance near the edge of a worktop during operation.
- 14 To protect against electrical shock **DO NOT** immerse cord, plugs or main unit housing in water or other liquid. Cook only in the basket provided.
- 15 **DO NOT** use an extension cord. A short power-supply cord is used to reduce the risk of children grabbing the cord or becoming entangled and to reduce the risk of people tripping over a longer cord.
- 16 **DO NOT** use the appliance if there is damage to the power cord or plug. Regularly inspect the appliance and power cord. If the appliance malfunctions or has been damaged in any way, immediately stop use and call Customer Service.
- 17 The appliance is not intended to be operated by means of an external timer or separate remote-control system.
- 18 **ALWAYS** ensure the appliance is properly assembled before use.
- 19 **DO NOT** cover the top air intake vent or rear air socket vent while lid is closed. Doing so will prevent even cooking and may damage the unit or cause it to overheat.
- 20 **DO NOT** use accessory attachments not recommended or sold by SharkNinja. **DO NOT** place accessories in a microwave, toaster oven, convection oven or conventional oven or on a ceramic cooktop, electrical coil, gas burner range or outdoor grill. The use of accessory attachments not recommended by SharkNinja may cause fire, electric shock or injuries.
- 21 When using this appliance, provide at least 15.25cm of space above and on all sides for adequate air circulation.
- 22 **ALWAYS** follow the maximum and minimum quantities of liquid as stated in instructions and recipes.
- 23 To avoid possible steam damage, place the unit away from walls and cupboards during use.
- 24 **NEVER** use **RAPID COOKER** functions without adding water and or ingredients to bottom of removable cooking pot.
- 25 **NEVER** use **SLOW COOK** setting without food and liquids in the removable cooking pot.
- 26 **DO NOT** move the appliance when in use.
- 27 Prevent food contact with heating elements. **DO NOT** overfill or exceed the MAX fill level of the cooking pot. Overfilling may cause personal injury or property damage or affect safe use of the appliance.
- 28 **DO NOT** use this unit to cook instant rice.

- 29** Electrical socket voltages can vary, affecting the performance and heat output of your product. To prevent possible illness, use a probe to check that your food is cooked to the temperatures recommended.
- 30** Should the unit emit black smoke, unplug immediately and wait for smoking to stop before removing the cooking pot and Cook & Crisp tray.
- 31** **DO NOT** touch hot surfaces. Appliance surfaces are hot during and after operation. To prevent burns or personal injury, **ALWAYS** use protective hot pads or insulated oven gloves and use available handles and knobs.
- 32** Extreme caution must be used when moving an appliance containing hot oil or other hot liquids. Improper use, including moving the cooker, may result in personal injury such as serious burns.
- 33** When unit is in operation, hot steam is released through the air socket vent. Place unit so vent is not directed toward the power cord, electrical sockets, cupboards or other appliances. Keep your hands and face at a safe distance from vent.
- 34** When using SLOW COOK setting, **ALWAYS** keep the lid closed.
- 35** The cooking pot and Cook & Crisp tray become extremely hot during the cooking process. Avoid hot steam and air while removing the cooking pot and Cook & Crisp tray from the appliance and **ALWAYS** place them on a heat-resistant surface after removing. **DO NOT** touch accessories during or immediately after cooking.
- 36** **ONLY** lift the lid from the handle on the front of the unit. **DO NOT** lift lid from side area as scalding steam will release.
- 37** Removable cooking pot can be extremely heavy when full of ingredients. Care should be taken when lifting pot from cooker base.
- 38** **DO NOT** touch accessories during or immediately after cooking, as they become extremely hot during the cooking process. To prevent burns or personal injury, **ALWAYS** use care when handling the product. Use long-handed utensils and protective hot pads or insulated oven gloves.
- 39** Cleaning and user maintenance shall not be done by children.
- 40** Allow unit to cool before cleaning, disassembly, putting in or taking off parts and storage.
- 41** When not in use and before cleaning, turn the unit off and unplug from socket to disconnect.
- 42** **DO NOT** clean with metal scouring pads. Pieces can break off the pad and touch electrical parts, creating a risk of electric shock.
- 43** Please refer to the Cleaning & Maintenance section for regular maintenance of the appliance.



Indicates to read and review instructions to understand operation and use of product.



Indicates the presence of a hazard that can cause personal injury, death or substantial property damage if the warning included with this symbol is ignored.



Take care to avoid contact with hot surface. Always use hand protection to avoid burns.



For indoor and household use only.

SAVE THESE INSTRUCTIONS

PARTS & ACCESSORIES

- A** Cook & Crisp tray
- B** 5.7L Removable Cooking Pot
- C** Lid Handle
- D** Cooker Lid
- E** Heating Element
- F** Control Panel
- G** Cooker Base
- H** Smart Switch
- I** Air Outlet Vent
- J** Condensation Collector

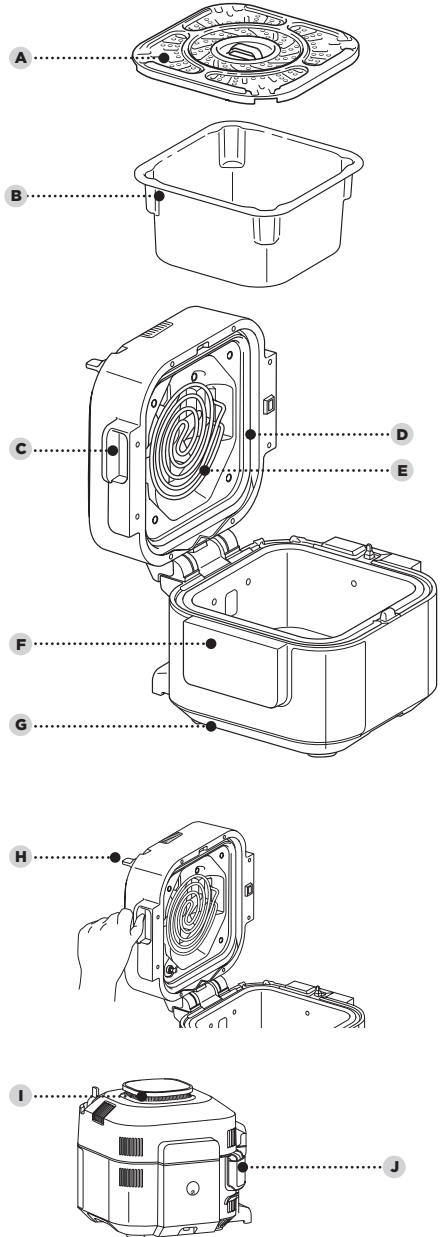

BEFORE FIRST USE

- 1** Remove and discard any packaging material and tape from the unit. Some stickers are to be permanently kept on the unit, **ONLY** remove stickers with 'peel here'.
- 2** Pay particular attention to operational instructions, warnings and important safeguards to avoid any injury or property damage.
- 3** Wash the removable pot, Cook & Crisp tray and condensation collector in warm, soapy water, then rinse and dry thoroughly.

To order additional or replacement parts and accessories, visit ninjakitchen.co.uk.

ACCESSORY ASSEMBLY & SMART SWITCH

ACCESSORY ASSEMBLY INSTRUCTIONS

COOK & CRISP TRAY

Top Position

Use top position for proteins and vegetables when following recipe instructions for Speedi Meals or when using Grill.



Bottom Position

Use bottom position for traditional steam and air frying capabilities.

Be sure to reference charts and recipes for crisper tray position recommendations.



To set up the Cook & Crisp Tray in the top position, first rotate the tray's legs outward, so that they extend past the four corners of the tray. The legs should sit on the ledges at the base of each groove, allowing the tray to remain elevated in the pot.

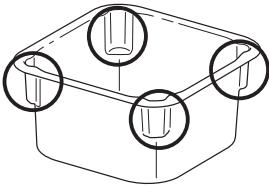

NOTE: Before placing the Cook & Crisp Tray in the top position, make sure to add any ingredients needed at the bottom of the pot.

NOTE: Recipes using the Speedi Meals function require that the Cook & Crisp Tray be set up in the top position.

To set up the Cook & Crisp Tray in the bottom position, rotate the tray's legs inward so that they are turned against the underside of the tray. This will allow the Cook & Crisp Tray to rest at the bottom of the pot.

USING THE SMART SWITCH

The SmartSwitch allows you to change between the two cook modes, which are labelled on the switch for your reference:

- Rapid Cooker
- Air Fry/Hob

The SmartSwitch's position will determine which cooking functions are available for selection.

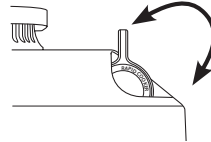

HOW TO OPEN & CLOSE THE LID

To open or close the lid at any time, use the handle that is located front centre of the unit, just above the control panel.

You can open and close the lid when the SmartSwitch is in either the RAPID COOKER or AIR FRY/HOB position.

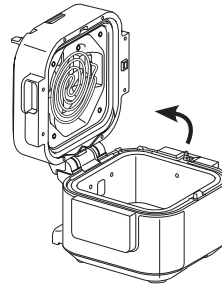

REMOVING & INSTALLING THE CONDENSATION COLLECTOR

To install the condensation collector, slide it into the slot on the cooker base. Slide it out to remove it for hand-washing after each use.

NOTE: Make sure to empty out excess water collected in the condensation collector after cooking.

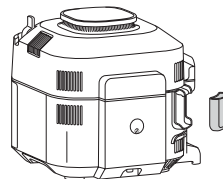

USING THE CONTROL PANEL

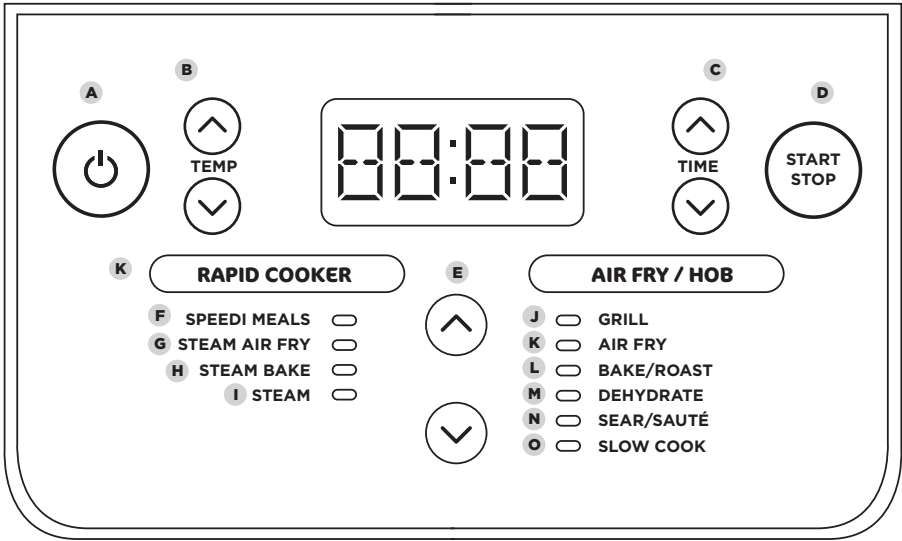

OPERATING BUTTONS

- A** : The power button shuts the unit off and stops all cooking functions.
- B** **LEFT ARROWS:** Use the up/down arrows to the left of the display to adjust the cooking temperature.
- C** **RIGHT ARROWS:** Use the up/down arrows to the right of the display to adjust the cooking time.
- D** **START/STOP button:** Press to start cooking. Pressing the button while the unit is cooking will stop the current cooking function.
- E** **CENTRE ARROWS:** Once you've chosen a mode using the SmartSwitch, use the centre arrows to scroll through the available functions until your desired function is highlighted.

COOKING FUNCTIONS

RAPID COOKER

- F** **SPEEDI MEALS:** Use to create quick and delicious meals in under 30 minutes.
- G** **STEAM AIR FRY:** Use to create a combination of juicy and crisp results.
- H** **STEAM BAKE:** Bake fluffy cakes and quick breads.
- I** **STEAM:** Gently cook delicate foods at a high temperature.

AIR FRY / HOB MODE

- J** **GRILL:** Use high heat from above to caramelize and brown the tops of your food.
- K** **AIR FRY:** Give food crispness and crunch with little to no oil.
- L** **BAKE/ROAST:** Use the unit like an oven with dry heat for tender meats, baked treats and more.
- M** **DEHYDRATE:** Dehydrate meats, fruits and vegetables for healthy snacks.
- N** **SEAR/SAUTÉ:** Use the unit as a hob for browning meats, sautéing vegetables, simmering sauces and more.
- O** **SLOW COOK:** Cook your food at a lower temperature for a longer period of time.

USING THE RAPID COOKER FUNCTIONS

To turn on the unit, plug the power cord into a wall socket, then press the  button.

Speedi Meals

- 1 Be sure to remove the Cook & Crisp tray from bottom of pot before getting started.
- 2 Add liquid and ingredients according to recipe in bottom of pot.
- 3 Pull out the legs on the Cook & Crisp tray, then place the tray in the top position in the pot. Add ingredients to the tray per recipe instructions.

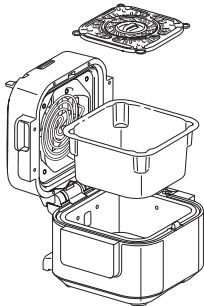

- 4 Move the SmartSwitch to RAPID COOKER, then use the centre arrows to select SPEEDI MEALS. The default setting will display. Use up and down arrows to the left of the display to choose a temperature from 150°C to 240°C in 5 degree increments.

NOTE: For temperatures over 210°C, the max cook time is 30 minutes.

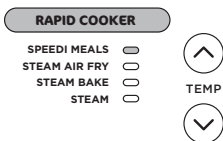

- 5 Use the arrows to the right of the display to adjust the cook time in 1 minute increments up to 1 hour.
- 6 Press START/STOP to begin cooking.
- 7 The display will show progress bars, indicating the unit is building steam. When the unit reaches the appropriate steam level, the timer will begin counting down.

- 8 When cook time reaches zero, the unit will beep and display "End". If your food requires more time, use the up arrows to the right of the display to add additional time. The unit will skip preheating.

NOTE: When cooking is complete, remove proteins and or vegetables from the Cook & Crisp tray. Then use silicone tipped tongs to grab the centre handles and remove the tray from the unit.

Steam Air Fry

- 1 Load ingredients according to recipe.
- 2 Move SmartSwitch to RAPID COOKER. Use the centre arrows to select STEAM AIR FRY. The default setting will display. Use the up and down arrows to the left of the display to choose a temperature from 150°C to 220°C in 5 degree increments.



- 3 Use the up and down arrows to the right of the display to adjust the cook time from 1 minute to 1 hour, in 1 minute increments and from 1 hour to 4 hours in 5 minute increments.

NOTE: For temperatures over 210°C, the max cook time is 30 minutes.

- 4 Press START/STOP to begin cooking.
- 5 The display will show progress bars, indicating the unit is building steam.
- 6 When the unit reaches the appropriate steam level, the timer will begin counting down.



- 7 When cook time reaches zero, the unit will beep and display "End". If your food requires more time, use the up arrow to the right of the display to add additional time. The unit will skip preheating.

USING THE RAPID COOKER FUNCTIONS - CONT.

Steam Bake

- 1 Be sure to place the Cook & Crisp tray in the bottom position. Place the baking accessories on top of the tray.
- 2 Move SmartSwitch to RAPID COOKER, then use the centre arrows to select STEAM BAKE. The default temperature setting will display. Use the up and down arrows to the left of the display to choose from 120°C to 210°C in 5 degree increments.
- 3 Use the up and down arrows to the right of the display to adjust the cook time from 1 minute to 1 hour and 15 minutes, in 1 minute increments.
- 4 Press START/STOP to begin cooking.
- 5 The display will show progress bars indicating the unit is building steam.



- 6 When preheating has completed, the timer will begin counting down.
- 7 When cook time reaches zero, the unit will beep and display "End". If your food requires more time, use the up arrow to the right of the display to add additional time. The unit will skip preheating.

Steam

- 1 To get started, add water to bottom of the pot. Be sure to place Cook & Crisp tray in bottom position and add ingredients.

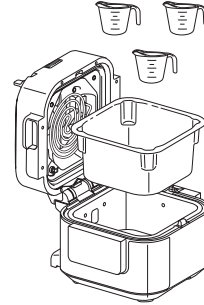

- 2 Move SmartSwitch to RAPID COOKER, then use the centre arrows to select STEAM.

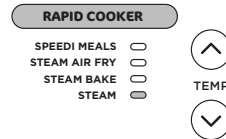

- 3 Use the up and down arrows to the right of the display to adjust the cook time up to 1 hour in 1 minute increments.
- 4 Press START/STOP to begin cooking.

NOTE: There is no temperature adjustment when using the STEAM function.

- 5 The unit will begin preheating to bring the liquid to a boil. The display will show progress bars indicating the unit is building steam. When preheating has completed, the display will show the set temperature and the timer will begin counting down. The preheating animation will show until the unit reaches temperature and then the display will show the timer counting down.



- 6 When cook time reaches zero, the unit will beep and display "End".

USING THE AIR FRY/HOB FUNCTIONS

Grill

- 1 Be sure to place the Cook & Crisp tray in the top position.

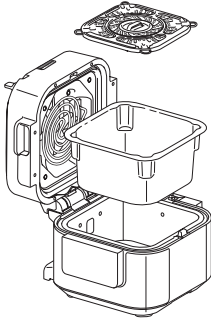

- 2 Place ingredients on the Cook & Crisp tray then close the lid.

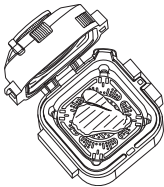

- 3 Move SmartSwitch to AIR FRY/HOB, then use the centre arrows to select GRILL. The default temperature setting will display. Use the up and down arrows to the left of the display to choose a temperature from 210°C to 240°C.



- 4 Use the up and down arrows to the right of the display to adjust the cook time up to 30 minutes in 1 minute increments.
- 5 Press START/STOP to begin cooking.
- 6 When cook time reaches zero, the unit will beep and display "End".

NOTE: Before using Air Fry, allow the unit to preheat for 5 minutes as you would your conventional oven.

Air Fry

- 1 Be sure to place the Cook & Crisp tray in the bottom position.
- 2 Add ingredients to the pot and close the lid.

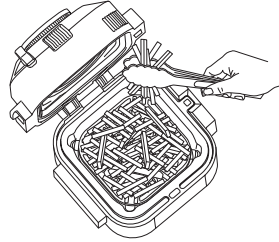

- 3 Move SmartSwitch to AIR FRY/HOB, the unit will default to AIR FRY. The default temperature setting will display. Use the up and down arrows to the left of the display to choose a temperature from 150°C to 210°C.

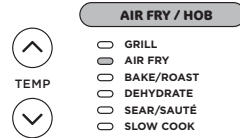

- 4 Use the up and down arrows to the right of the display to adjust the cook time in 1 minute increments up to 1 hour.
- 5 Press START/STOP to begin cooking.

NOTE: For best results, it is recommended to periodically shake ingredients during air frying. You can open the lid and lift out the pot to shake or toss ingredients for even browning. When done, lower the pot back into the unit and close the lid. Cooking will automatically resume after the lid is closed.

- 6 When cook time reaches zero, the unit will beep and "End".

USING THE AIR FRY/HOB FUNCTIONS – CONT.

NOTE: Before using Bake/Roast, allow the unit to preheat for 5 minutes as you would your conventional oven.

Bake/Roast

- 1 Be sure to position the Cook & Crisp tray in the bottom of the pot.
- 2 Move SmartSwitch to AIR FRY/HOB, then use the centre arrows to select BAKE/ROAST. The default temperature setting will display. Use the up and down arrows to the left of the display to choose a temperature from 120°C to 210°C.

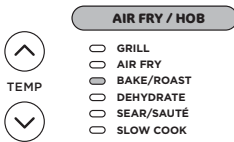

- 3 Use the up and down arrows to the right of the display to adjust the cook time up to 1 hour in 1 minute increments and from 1 hour to 4 hours in 5 minute increments.
- 4 Press START/STOP to begin cooking.
- 5 When cook time reaches zero, the unit will beep and "End".

Dehydrate

- 1 Be sure to place the Cook & Crisp tray in the bottom position.

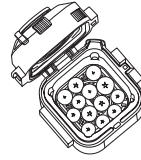

- 2 Move SmartSwitch to AIR FRY/HOB, then use the centre arrows to select DEHYDRATE. The default temperature setting will display. Use the up and down arrows to the left of the display to choose a temperature between 40°C and 90°C.

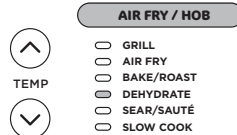

- 3 Use the up and down arrows to the right of the display to adjust the cook time between 1 and 12 hours, in 15 minute increments.
- 4 Press START/STOP to begin cooking.
- 5 When cook time reaches zero, the unit will beep and "End".

Sear/Sauté

- 1 Before getting started, be sure to remove the Cook & Crisp tray from the pot. Add ingredients to the pot.
- 2 Move SmartSwitch to AIR FRY/HOB then use the centre arrows to select SEAR/SAUTÉ. The default temperature setting will display. Use the up and down arrows to the left of the display to select "Lo1," "2," "3," "4," or "Hi5."

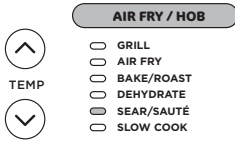

NOTE: There is no time adjustment available when using the Sear/Sauté function.

- 3 Press START/STOP to begin cooking.
- 4 Press START/STOP to turn off the SEAR/SAUTÉ function. To switch to a different cooking function, press START/STOP to end the cooking function then use the Smart Switch and centre arrows to select your desired function.

NOTE: You can use this function with the lid open or with the lid closed.

NOTE: ALWAYS use nonstick utensils in the cooking pot. **DO NOT** use metal utensils, as they will scratch the nonstick coating on the pot.

NOTE: SEAR/SAUTÉ will automatically turn off after 1 hour for "4" and "Hi5" and 4 hours for "LO1," "2," and "3."

Slow Cook

- 1 Before getting started, be sure to remove the Cook & Crisp tray and add ingredients to the bottom of the pot. **DO NOT** fill the pot past the max fill line (indicated on the inside of the pot).
- 2 Move SmartSwitch to AIR FRY/HOB, then use the centre arrows select SLOW COOK. The default temperature setting will display. Use the up and down arrows to the left of the display to select "Hi," "Lo," or "bUFFET".

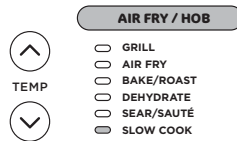

- 3 Use the up and down arrows to the right of the display to adjust the cook time.

NOTE: The SLOW COOK BUFFET time setting may be adjusted between 2 and 12 hours; the SLOW COOK LO time setting may be adjusted between 6 and 12 hours. The SLOW COOK HI time setting may be adjusted between 4 and 12 hours.

- 4 Press START/STOP to begin cooking.
- 5 When cook time reaches zero, the unit will beep, automatically switch to Keep Warm mode and begin counting up.

CLEANING & MAINTENANCE

Dishwasher & Hand-Washing

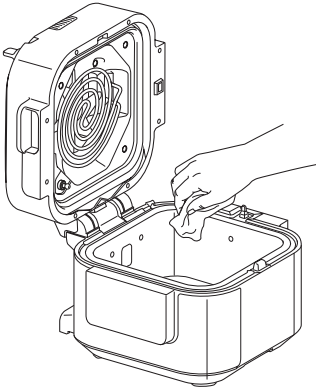

The unit should be cleaned thoroughly after every use.

- 1 Unplug the unit from the wall socket and ensure the unit is completely cool before cleaning.
- 2 To clean the cooker base and the control panel, wipe them clean with a damp cloth.
- 3 The cooking pot, Cook & Crisp tray and condensation collector can be washed in the dishwasher.

NOTE: NEVER put the cooker base the dishwasher or immerse it in water or any other liquid.

- 4 If the food residue is stuck on the pot, Cook & Crisp tray, fill the pot with water and allow to soak before cleaning. **DO NOT** use scouring pads. If scrubbing is necessary, use a non-abrasive cleanser or washing up liquid with a nylon pad or brush.
- 5 Air-dry all parts after each use.

CLEANING THE LID

We recommend inspecting the interior of the lid prior to cooking with “wet cooking functions,” which include Slow Cook, Sear/Sauté and all Rapid Cooker functions. If you see any food residue or oil buildup on the heating element or fan, we recommend steam cleaning the unit (see instructions below), then wiping down the interior of the lid.

STEAM CLEANING INSTRUCTIONS:

- 1 Fill pot with 700ml of water.

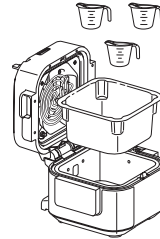

- 2 Move Smart Switch to RAPID COOKER.

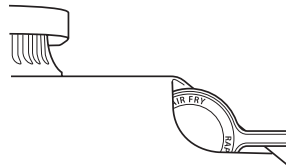

- 3 Select STEAM and set time to 30 minutes. Press START/STOP.
- 4 When time reaches zero and the unit has cooled down, use a wet cloth or sponge to wipe down the interior of the lid. **CAUTION:** When cleaning the interior of the lid, do not touch the fan.
- 5 Repeat steps 3 and 4 as needed and spot clean as necessary.
- 6 Remove water from pot and be sure to rinse both the cooking pot and Cook & Crisp tray to ensure all residue is removed.

NOTE: Make sure to empty out excess water collected in the condensation collector.

TROUBLESHOOTING GUIDE

How do I pressure cook?

- This unit **does not** have the pressure cook function. Instead cook quickly using the RAPID COOKER functions. Refer to the recipe guide for inspiration.

Progress bars are shown on the display screen when using RAPID COOKER functions.

- This indicates the unit is building steam. When the unit has finished, your set cook time will begin counting down.

There is a lot of steam coming from the unit when using the RAPID COOKER functions.

- It's normal for steam to release through the vent during cooking. Allow adequate space when using this appliance and ensure the vent is not directed towards the power cord, electrical socket or cupboards.

The unit is counting up rather than down.

- The cooking cycle is complete and the unit is in Keep Warm mode.

“ADD POT” error message appears on display screen.

- Cooking pot is not inside the cooker base. Cooking pot is required for all functions.

“SHUT LID” error message appears on display screen.

- The lid is open and needs to be closed for the selected function to start.

“ERR” message appears.

- The unit is not functioning properly. Please contact Customer Service at 0800 862 0453.

HELPFUL TIPS

- 1** When referencing our Meal Charts in the Recipe Book, for larger cuts of meat add 3 to 5 minutes to the cook time (but please note this may overcook grains). We recommend sticking to suggested height and weight of meats.
- 2** For consistent browning, make sure ingredients are arranged in an even layer on the bottom of the cooking pot with no overlapping. If ingredients are overlapping, make sure to shake halfway through the set cook time.

VISIT US ONLINE AT:

ninjakitchen.co.uk

Or follow us on any of our social media pages:



@ninjakitchenuk



NOTE: Save these instructions. Keep for future reference.



This marking indicates this product should not be disposed of with other household waste. To prevent possible harm to the environment or human health from uncontrolled waste disposal, recycle it responsibly to promote the sustainable reuse of material resources. To return your used device, please use the return and collection systems or contact the retailer where this product was purchased. They can take this product for environmentally safe recycling.

**SharkNinja Europe Limited,
3150 Century Way,
Thorpe Park,
Leeds,
LS15 8ZB, UK
0800 862 0453
ninjakitchen.co.uk**

**SharkNinja Germany GmbH,
c/o Regus Management GmbH,
Excellent Business Centre 10.+11. Stock,
Westhafenplatz 1,
60327 Frankfurt am Main,
Germany**

Illustrations may differ from actual product. We are constantly striving to improve our products, therefore the specifications contained herein are subject to change without notice.

NINJA is a registered trademark in the United Kingdom of SharkNinja Operating LLC.
COOK & CRISP, RAPID COOKER AND SPEEDI are unregistered trademarks in the United Kingdom of SharkNinja Operating LLC.

© 2022 SharkNinja Operating LLC

ON400UK_IB_MP_221118_Mv1
PRINTED IN CHINA

